

Stack Dimensions

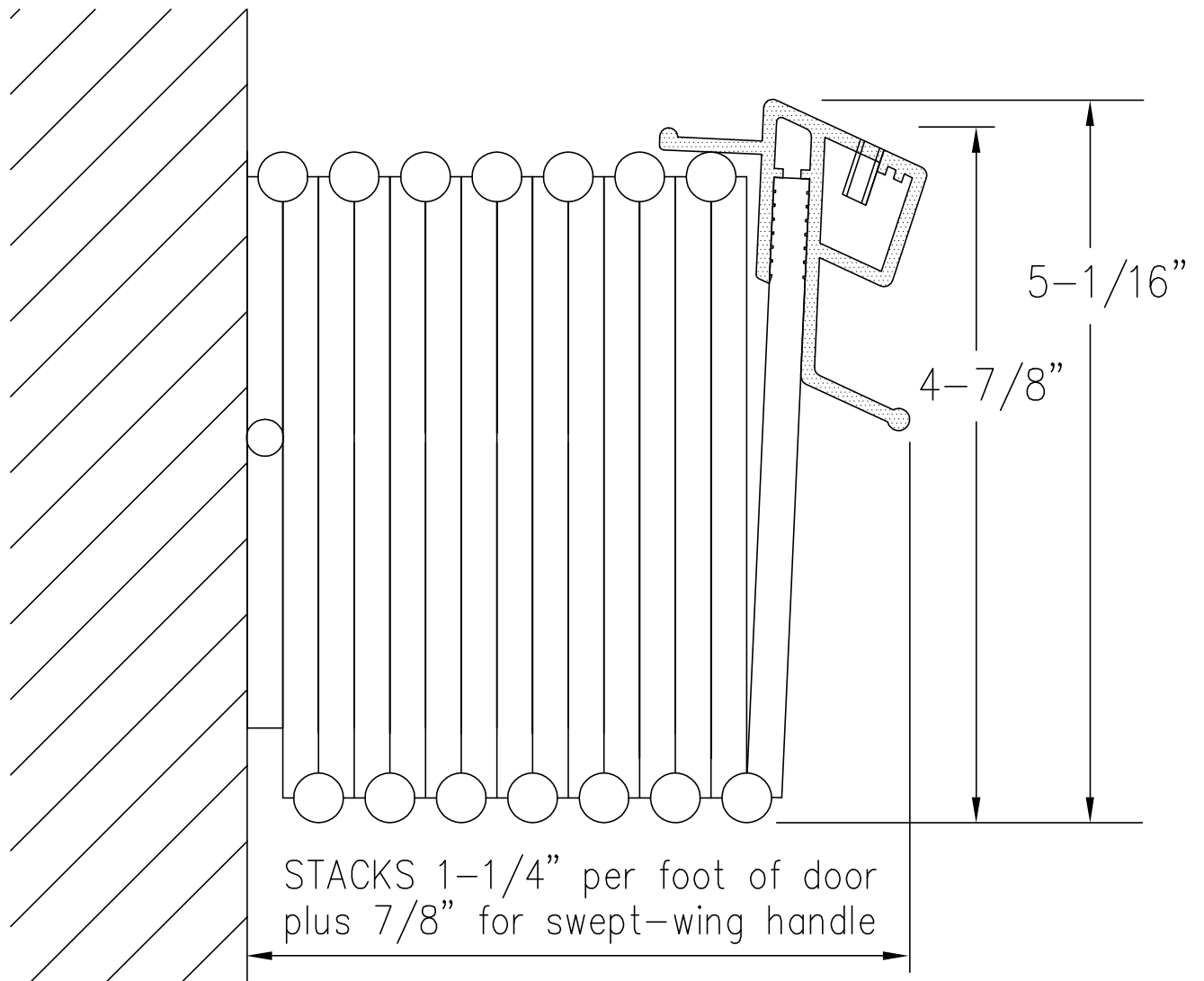

CAD STD M-220

○ STACK DIMENSIONS — MODEL 220