

# Stack Dimensions

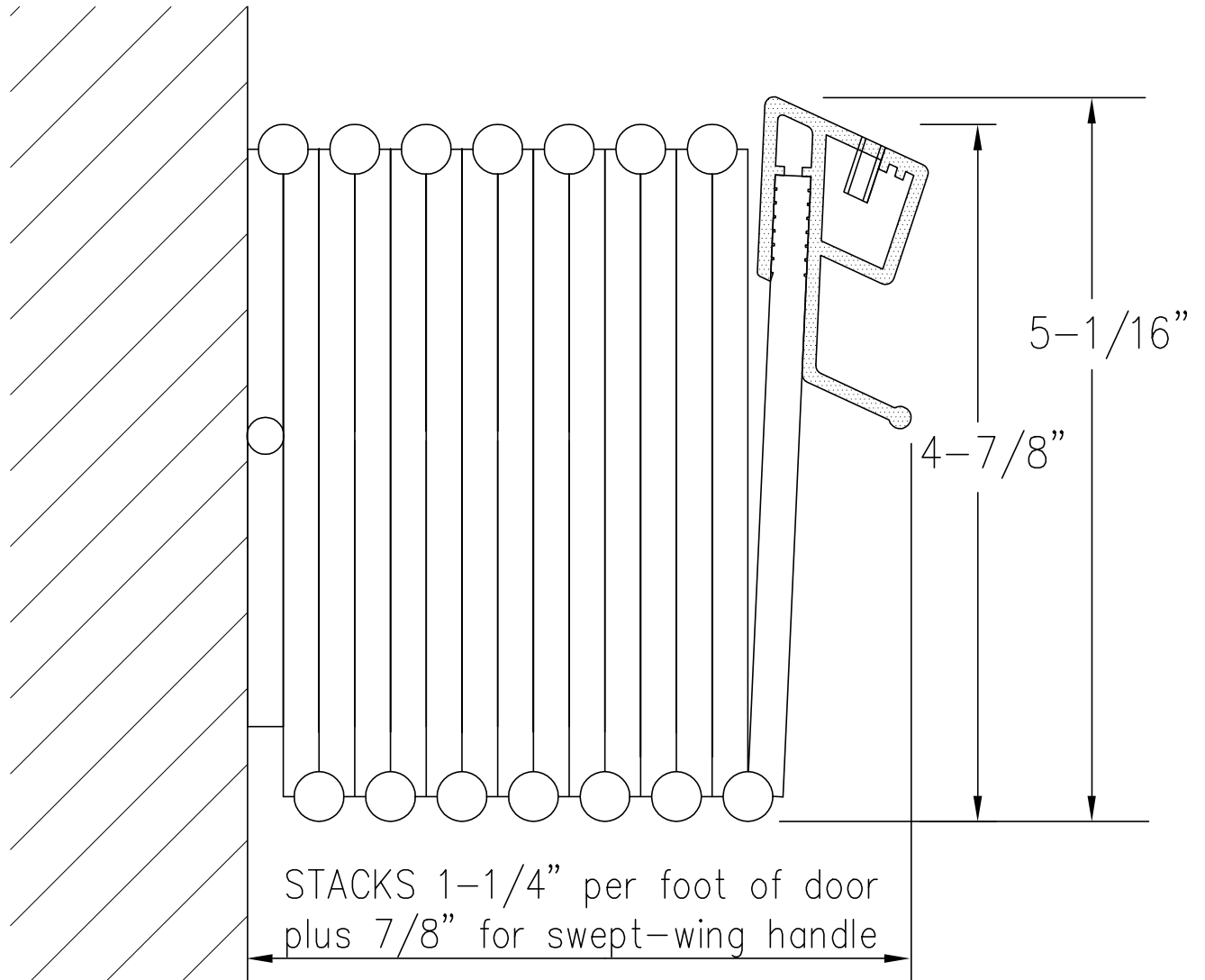

CAD STD M-140

○ STACK DIMENSIONS — MODEL 140